



STEALTH
mobiado

mobiado

Mobiado

First edition (December 2007)

This manual is published by Bonac Innovation Corporation, without any warranty. Improvements and/or changes to this manual made necessary by typographical errors, inaccuracies of current information, or improvements to programs and/or equipment, may be made by Bonac Innovation Corporation at any time and without notice. However, any such changes shall be incorporated into new editions of this manual.

Under no circumstances shall Bonac Innovation be responsible for any loss of data or income or any special, incidental, consequential or indirect damages howsoever caused.

All rights reserved.

©Bonac Innovation Corporation, 2007

Mobiado Package Contents

- 1 Mobiado Stealth Phone
- 1 Battery
- 1 Headset
- 1 MicroSD Card
- 1 Charger
- 1 Cleaning Cloth
- 1 Cleaning Pouch
- 1 User Guide

Safety Information

Obey all local laws. Keep your hands free to operate your vehicle.

Switch off your phone in all restricted areas, including hospitals, aircrafts, blasting areas, and during refueling at gas stations.

All wireless phones can be susceptible to interference which can affect performance.

Remember to back up all important phone information you have.

Keep your phone dry at all times. Moisture can damage your phone.

Do not place your phone in cold or hot places. Extreme temperatures can damage your phone.

Do not attempt to open your phone, non-expert handling can damage your phone.

Code Information

A security code protects your phone from unauthorized use. It is preset to 12345. If you enter your security code incorrectly 5 times in succession, you must wait 5 minute to enter your security code again.

1. Getting Started

▪ SIM card and battery installation

Be careful not to damage the SIM card when installing and removing. Keep out of the reach of small children.

Make sure the phone is turned off and remove any enhancements.

Slide down and hold the release button and lift the battery cover.

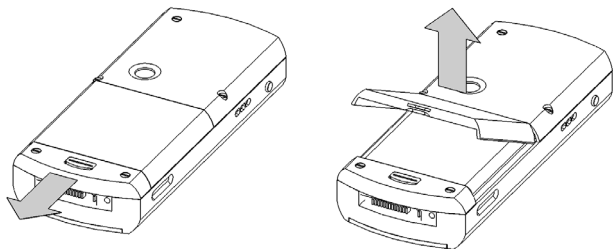

Remove battery by lifting. Pull up the locking clip.

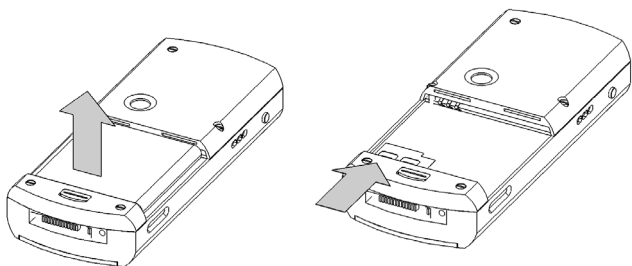

Insert the SIM card. Make sure the golden contact area is facing downwards.

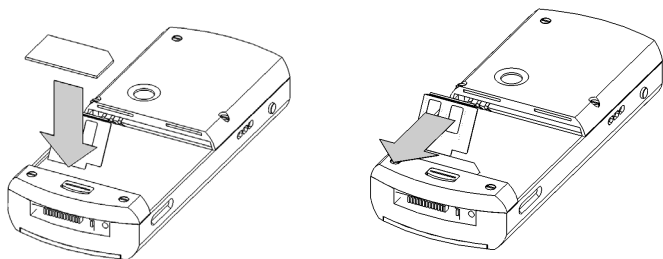

Close the locking clip.

Replace battery.

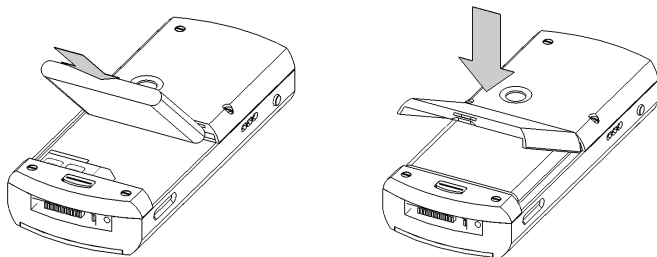

Slide the release button down and place the battery cover back in place.

▪ Charging the battery

Connect the charger lead to the bottom of your phone, and connect the charger plug into your wall socket.

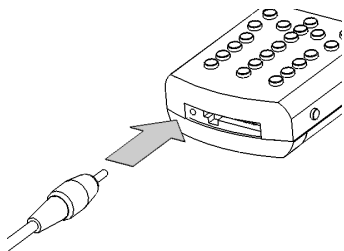

If your battery is completely flat, it may take a few minutes for the charging to begin or before any calls can be made.

▪ Switching the phone on and off

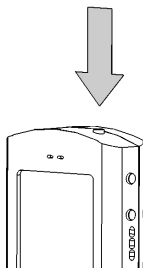

Press and hold the power button. If the phone asks for a PIN code, key in the PIN code and press **OK**.

▪ Normal operating position

Do not place fingers on RF window when operating your phone. Your phone has a built in antenna, and as with any radio transmitting device, contact with the antenna might disrupt the signal.

▪ Installing microSD card

Use only compatible microSD cards. Other media types (such as reduced size MMCs) are not compatible and may damage your phone as well as your incompatible card.

MicroSD cards can be added and removed from the phone without turning the phone off. **(Note:** Do not remove the microSD card during an operation that is using the card. To do so might cause damage to the microSD card and/or your phone.)

Place the microSD card in the card holder as shown below. Make sure the card is properly oriented and click into place. The golden contacts must facing upwards as shown.

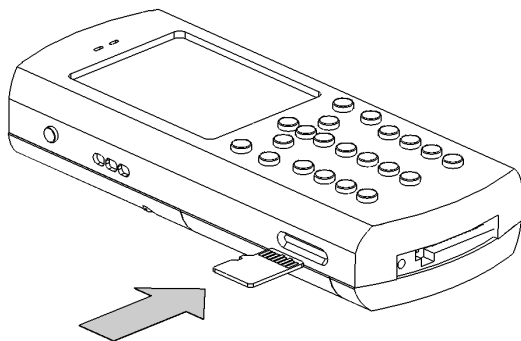

2. Mobiado Stealth

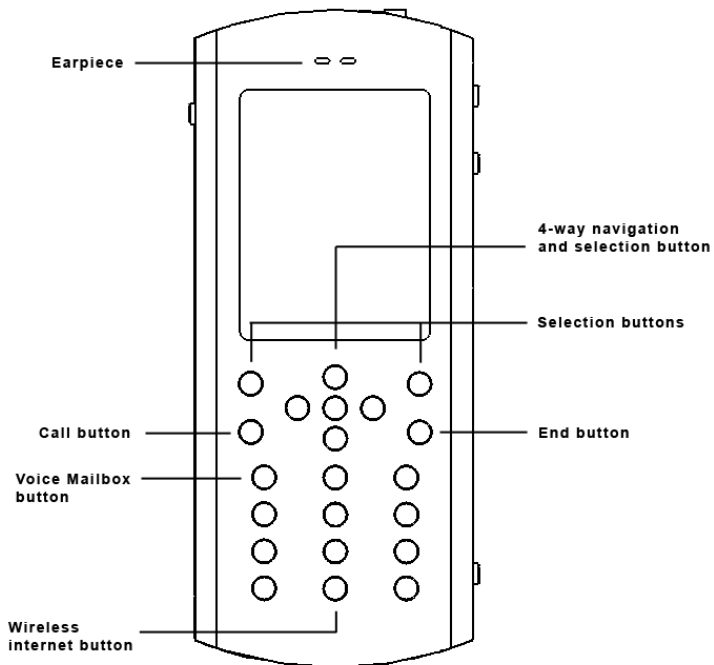

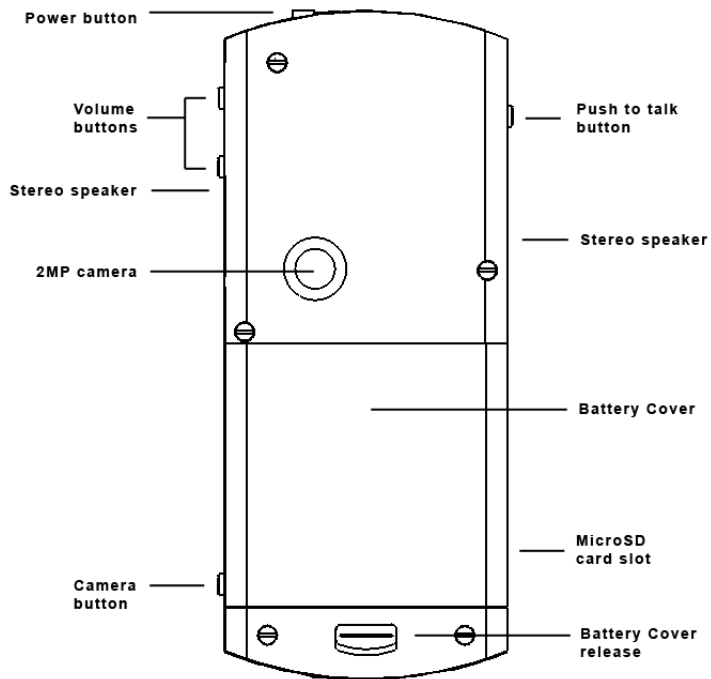

3. General Use

- **Making a call and organizing contacts**

Type in the phone number (press **Clear** to delete any incorrect characters).

For international calls, press ***+** twice for the “+” symbol (this replaces the international access code). Type in the country code without the leading “0”, if necessary, and then the number.



Press  to call.

Press  to end or cancel the call.

Search for a contact phone number by pressing **Menu** and select “Contacts” and “Search” or by pressing down on the navigation buttons in standby mode.

Press  to call.

Save a phone number by pressing **Menu** then selecting “Contacts” and “Add contact”. Enter the name and number. When they are saved, press **Done**.

To call one of the last 20 phone numbers dialed by pressing , scrolling to the desired number and press  again.

- **Speed dial**

You can assign a speed dial number to a phone number by pressing **Menu**, selecting “Contacts” and “Speed dials” and then scrolling to the number button you want.

Press **Assign**, or if already assigned, press **Options** and select “Change”.

Press **Search** and select the name and number you want.

▪ Answering and rejecting calls

Press **]** to answer a call and **[** to reject or to end a call.

Press **Silence** to mute a ring tone.

If you receive a call during another call, press **]** to answer the second call and put the first call on hold. Press **[** to end the active call.

▪ Enhanced voice dialing

To make a phone call, press and hold the right selection button, and say the name of the person you wish to call. Your phone will automatically associate a virtual voice tag with each contact you have in your phone memory.

▪ Call options

These are the options you can choose from during a call (if available by your network provider):

Call options are:

“Mute” or “Unmute”, “Contacts”, “Menu”, “Lock keypad”, “Record”, “Loudspeaker”, or “Handset”.

Network service options are:

“Answer”, “Reject”, “Hold” or “Unhold”, “New call”, “Add to conference”, “End call”, “End all calls” and

“Send DTMF” to send tones strings

“Swap” to switch between the call on hold and the active call

“Transfer” to connect an active call with the call on hold and disconnect yourself

“Conference” allows up to 5 people to be in a conference call

“Private call” to talk privately during a conference call.

Note: Do not hold your phone close to your ears in loudspeaker mode because the volume may be extremely loud.

▪ **Writing text**

There are two methods to key in text: the traditional method and the predictive text method.

Press **#** to change between character cases (Abc, abc, ABC).

Press and hold **#** to change between numbers and letters.

Turn predictive text on and off by pressing **Options** and selecting “Prediction on” for predictive text method or “Prediction off” for traditional text method.

The traditional method for typing text is to press a single button multiple times in quick succession to get the desired letter. (Example: press **2abc**, three times to get “c”)

The predictive method for typing text is to press each letter once and let the phone decipher the word. (Example: press **2abc**, **2abc**, **7pqrs** to write “car”)

Press **0** to go to the next word.

If the word is not correct, press **Option** for your options.

▪ **Keypad lock**

The keypad can be locked or unlocked by pressing **Menu** or

Unlock and ****** within 1.5 seconds.

▪ **Video calling**

Video calling sends real time videos to the recipient using the camera on the back of your phone (there is no camera on the front of your phone). You must have a USIM card and be connected to a WCDMA network to be able to make video calls.

To make a video call, enter the phone number or find the contact in your address book. Press and hold the “Call” key or select “Contacts” and then select “Video Call”.

It may take a while for the video call to start. Press the end key to end the video call.

To receive a video call press the receive button. “Allow video image to be sent to caller” will be displayed. Select “Yes” to allow video image and “No” to not allow. Note that even when you deny video image, you will be charged video image rates.

4. Care and Maintenance

The Mobiado Stealth has been created from the finest of materials and must be handled with care. Only use the provided Mobiado cleaning cloth to wipe your phone. Do not use any solvents to clean your phone.

Keep your phone dry and do not store in dirty and dusty areas.

Do not store your phone in hot areas. High temperature can shorten the life of the electronics of your phone.

Do not store your phone in cold areas. Moisture can form and damage the electronics of your phone.

Do not attempt to open your phone other than instructed in this manual.

Always back up your files before sending to a service center for servicing.

Note: Damage caused by dropping your phone is not covered by the warranty.

5. Battery Information

The phone receives its power from a rechargeable battery. The battery is at maximum performance only after 2 or 3 complete cycles of charge and discharge.

The battery can be charged hundreds of times but will eventually wear out. If you notice a big change in operating time, replace your battery with a new one.

Use only batteries that are approved by the phone manufacturer. Unplug the phone once it is completely charged. Never leave the phone plugged in for longer than a week. Overcharging may shorten the life of your battery. The battery will gradually discharge by itself over time.

Extreme temperatures can affect the performance of your battery. Use the battery only for its intended use and never use a damaged battery.

Do not short-circuit the battery. This can occur if a conductive object (e.g. metallic) contacts the terminals (+ and -) at the same time.

Do not leave your battery in hot or cold places; it may reduce the capacity and lifespan of your battery. Keep your battery between 15°C and 25°C (59°F and 77°F). A battery that is hot or cold may temporarily not work, even if fully charged.

Never discard your battery in a fire. Discard your battery according to local regulations.

mobiado

www.mobiado.com